

**Immersion / screw-in / duct temperature measuring transducer, Bluetooth-enabled, with EtherCATP port**

Networkable temperature measuring transducer with sensor tube **THERMASGARD® TM65-EtherCATP** with M8 plug-in connector (EtherCATP-encoded), Bluetooth-enabled, in an impact-resistant plastic housing with quick-locking screws, optionally with /without display and bar graph.

The duct sensor is used to detect the temperature in liquid or gaseous media. Use the stainless steel immersion sleeves for aggressive media. It is used in heating engineering, ventilation and air conditioning ducts, pipes, storage systems, compact district heating stations, warm and cold water systems, oil and lubrication cycle systems, machine and systems engineering and the entire industry sector. The sensor is factory-calibrated.

**EtherCATP-enabled measuring transducer** for industrial requirements with maximum reliability: includes easy PLC integration using the device's ESI configuration file, diagnostics (such as communication failure counter), advanced settings options, access to historical data (min / max) and establishing the sensor's service interval. Optionally with large illuminated display (3-line, customised programming in the 7-segment and dot-matrix range) and bar graph (7-digit, LEDs freely configurable) for graphical display, e.g., as a traffic light indicator.

TM65-EtherCATP



**EtherCATP**  
Cable connection and LED status display

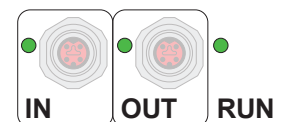

**TECHNICAL DATA**

Power supply:	24VDC via EtherCATP (U <sub>S</sub> )
Power consumption:	< 3W
Bus protocol:	<b>EtherCAT</b>
Radio technology:	<b>Bluetooth (LE)</b>
Sensor:	Pt1000, DIN EN 60751, class B ( <b>Perfect Sensor Protection</b> )
Measuring range:	-50...+150°C
Accuracy in temperature:	Typically ±0.2K at +25°C
Medium:	Clean air and non-aggressive, non-combustible gases; liquids depending on selected immersion sleeve (accessory)
Protective tube:	Stainless steel, <b>V4A</b> (1.4571), Ø = 6mm, installation length (IL) = 50-400mm (see table)
Housing:	Plastic, UV-resistant, polyamide material, 30% glass-globe reinforced, with quick-locking screws (slotted / Phillips head combination), colour traffic white (similar to RAL 9016), housing cover for display is transparent!
Housing dimension:	126 x 90 x 50mm (Tyr 2)
Cable connection:	<b>M8 plug-in connector</b> , EtherCATP-encoded
Ambient temperature:	Measuring transducer -30...+70°C
Permitted humidity:	<95% RH, non-precipitating air
Protection class:	III (according to EN 60730)
Protection type:	<b>IP 54</b> (according to EN 60529) when built-in
Standards:	CE conformity, according to EMC Directive 2014 / 30 / EU, according to RED 2014 / 53 / EU
Equipment:	<b>Display with illumination</b> , 3-line, customised programming, cutout approx. W51 x H29mm, to display the actual temperature or a customised display value. <b>Bar graph</b> , 7-digit, LEDs freely configurable, to graphically display the reading.

**ACCESSORIES** See table

EtherCAT P	LED status display
<b>1. LED</b>	<b>"IN"</b>
off	no connection to upstream EtherCAT module
illuminated	LINK: connection to upstream EtherCAT module
blinking	ACT: communication with upstream EtherCAT module
<b>2. LED</b>	<b>"OUT"</b>
off	no connection to downstream EtherCAT module
illuminated	LINK: connection to downstream EtherCAT module
blinking	ACT: communication with downstream EtherCAT module
<b>3. LED</b>	<b>"RUN"</b>
off	EtherCAT module is in "Init" state
quickly blinking	EtherCAT module is in "Pre-Operational" state
slowly blinking	EtherCAT module is in "Safe-Operational" state
illuminated	EtherCAT module is in "Operational" state

**The status LEDs are next to the cable connection.**

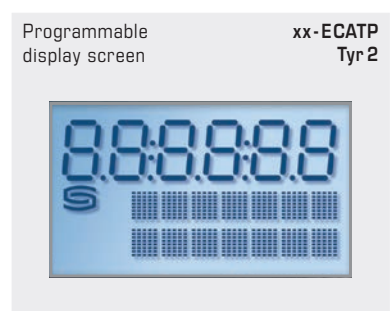
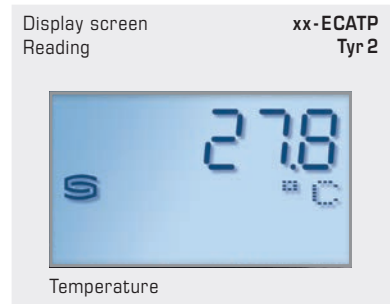



S+S REGELTECHNIK

THERMASGARD® TM65 - EtherCAT P

Immersion / screw-in / duct  
temperature measuring transducer, Bluetooth-enabled,  
with EtherCAT port

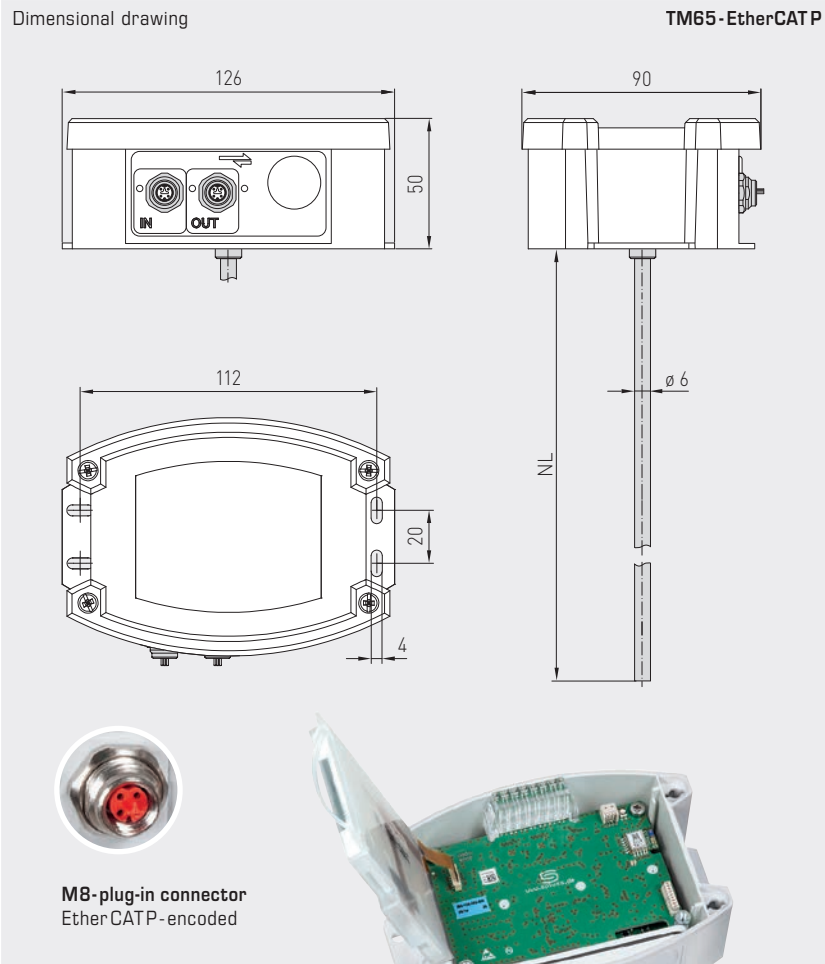

M8-plug-in connector  
EtherCAT P-encoded



TM65 - EtherCAT P  
with display and bar graph

High-performance encapsulation against  
vibration, mechanical stress and humidity

**PS-PROTECTION**  
PERFECT SENSOR PROTECTION

THERMASGARD® TM65 - EtherCAT P		Temperature measuring transducer (basic unit), with EtherCAT port				
Type / WG02	Measuring Range Temperature	Output	Inserted Length (EL)	Bar graph Display	Item No.	Price
TM65-ECATP xx						
TM65-ECATP 50mm	-50...+150 °C	EtherCAT P	50 mm		2001-4201-9100-011	366,30 €
TM65-ECATP 50mm LCD				<input type="checkbox"/> <input checked="" type="checkbox"/>	2001-4202-9100-011	415,86 €
TM65-ECATP 100mm	-50...+150 °C	EtherCAT P	100 mm		2001-4201-9100-021	366,76 €
TM65-ECATP 100mm LCD				<input type="checkbox"/> <input checked="" type="checkbox"/>	2001-4202-9100-021	416,32 €
TM65-ECATP 150mm	-50...+150 °C	EtherCAT P	150 mm		2001-4201-9100-031	367,26 €
TM65-ECATP 150mm LCD				<input type="checkbox"/> <input checked="" type="checkbox"/>	2001-4202-9100-031	416,79 €
TM65-ECATP 200mm	-50...+150 °C	EtherCAT P	200 mm		2001-4201-9100-041	367,71 €
TM65-ECATP 200mm LCD				<input type="checkbox"/> <input checked="" type="checkbox"/>	2001-4202-9100-041	417,26 €
TM65-ECATP 250mm	-50...+150 °C	EtherCAT P	250 mm		2001-4201-9100-051	368,16 €
TM65-ECATP 250mm LCD				<input type="checkbox"/> <input checked="" type="checkbox"/>	2001-4202-9100-051	417,71 €
TM65-ECATP 300mm	-50...+150 °C	EtherCAT P	300 mm		2001-4201-9100-061	368,63 €
TM65-ECATP 300mm LCD				<input type="checkbox"/> <input checked="" type="checkbox"/>	2001-4202-9100-061	418,17 €
TM65-ECATP 400mm	-50...+150 °C	EtherCAT P	400 mm		2001-4201-9100-081	369,10 €
TM65-ECATP 400mm LCD				<input type="checkbox"/> <input checked="" type="checkbox"/>	2001-4202-9100-081	418,63 €

Note: Cable connection with M8 plug-in connector (EtherCAT P-encoded)

Immersion / screw-in / duct  
temperature measuring transducer, Bluetooth-enabled,  
with EtherCAT port

One basic device in four variants ...



**TM65-ECATP +  
TH-MS/xx**

Immersion / screw-in  
temperature sensor  
with immersion sleeve, brass,  
nickel-plated / galvanised

**TM65-ECATP +  
TH-VA/xx**

Immersion / screw-in  
temperature sensor  
with immersion sleeve,  
stainless steel, V4A

**TM65-ECATP +  
TH-VA/xx/90**

Immersion / screw-in  
temperature sensor with  
immersion sleeve with  
neck tube, stainless steel, V4A

**TM65-ECATP +  
MF-06-K**

Duct temperature sensor  
with mounting flange,  
plastic

Dimensional drawing  
**TH-MS/xx**

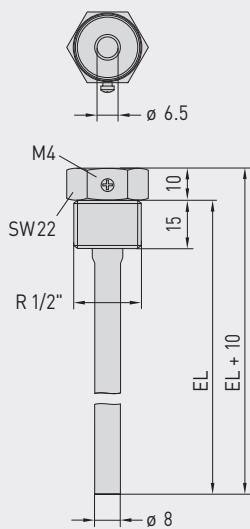

Dimensional drawing  
**TH-VA/xx**

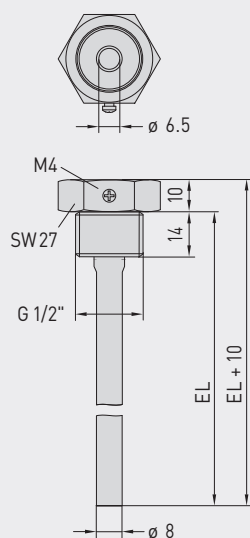

Dimensional drawing  
**TH-VA/xx/90**

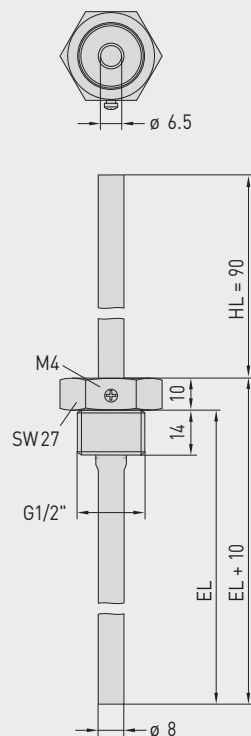

Dimensional drawing  
**MF-06-K**

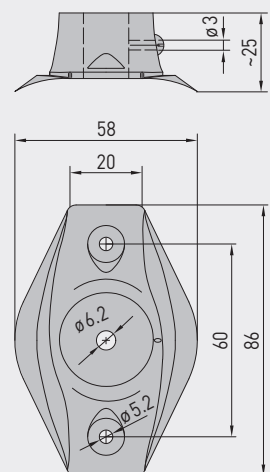



... through combination with accessories:



**TH-MS/xx**  
Immersion sleeve, brass, nickel-plated / galvanised, thread-sealing, conical, according to DIN 10226



**TH-VA/xx**  
Immersion sleeve, stainless steel, V4A, flat-sealing, cylindrical, according to DIN 228



**TH-VA/xx/90**  
Immersion sleeve with neck tube, stainless steel, V4A, flat-sealing, cylindrical, according to DIN 228



**MF-06-K**  
Mounting flange, plastic

THERMASGARD® TH Immersion sleeve Ø 8 mm (Accessories)					
Type / WG01	p <sub>max</sub> (static)	T <sub>max</sub>	Inserted Length (EL)	Item No.	Price
<b>TH-MS/xx</b>	<b>Brass nickel-plated / galvanised</b>			without neck tube	
TH-MS 50MM	10 bar	+150 °C	<b>50 mm</b>	7100-0011-0010-001	<b>9,97 €</b>
TH-MS 100MM	10 bar	+150 °C	<b>100 mm</b>	7100-0011-0020-001	<b>11,37 €</b>
TH-MS 150MM	10 bar	+150 °C	<b>150 mm</b>	7100-0011-0030-001	<b>12,00 €</b>
TH-MS 200MM	10 bar	+150 °C	<b>200 mm</b>	7100-0011-0040-001	<b>12,39 €</b>
TH-MS 250MM	10 bar	+150 °C	<b>250 mm</b>	7100-0011-0050-001	<b>14,34 €</b>
TH-MS 300MM	10 bar	+150 °C	<b>300 mm</b>	7100-0011-0060-001	<b>14,74 €</b>
TH-MS 350MM	10 bar	+150 °C	<b>350 mm</b>	7100-0011-0070-001	<b>14,86 €</b>
TH-MS 400MM	10 bar	+150 °C	<b>400 mm</b>	7100-0011-0080-001	<b>15,00 €</b>
<b>TH-VA/xx</b>	<b>Stainless steel V4A (1.4571)</b>			without neck tube	
TH-VA 50MM	40 bar	+600 °C	<b>50 mm</b>	7100-0012-0010-001	<b>21,73 €</b>
TH-VA 100MM	40 bar	+600 °C	<b>100 mm</b>	7100-0012-0020-001	<b>24,00 €</b>
TH-VA 150MM	40 bar	+600 °C	<b>150 mm</b>	7100-0012-0030-001	<b>25,79 €</b>
TH-VA 200MM	40 bar	+600 °C	<b>200 mm</b>	7100-0012-0040-001	<b>27,19 €</b>
TH-VA 250MM	40 bar	+600 °C	<b>250 mm</b>	7100-0012-0050-001	<b>33,80 €</b>
TH-VA 300MM	40 bar	+600 °C	<b>300 mm</b>	7100-0012-0060-001	<b>35,32 €</b>
TH-VA 350MM	40 bar	+600 °C	<b>350 mm</b>	7100-0012-0070-001	<b>35,56 €</b>
TH-VA 400MM	40 bar	+600 °C	<b>400 mm</b>	7100-0012-0080-001	<b>36,18 €</b>
<b>TH-VA/xx/90</b>	<b>Stainless steel V4A (1.4571)</b>			with neck tube (90 mm)	
TH-VA 50/90MM	40 bar	+600 °C	<b>50 mm</b>	7100-0012-2010-001	<b>31,11 €</b>
TH-VA 100/90MM	40 bar	+600 °C	<b>100 mm</b>	7100-0012-2020-001	<b>32,51 €</b>
TH-VA 150/90MM	40 bar	+600 °C	<b>150 mm</b>	7100-0012-2030-001	<b>34,11 €</b>
TH-VA 200/90MM	40 bar	+600 °C	<b>200 mm</b>	7100-0012-2040-001	<b>35,56 €</b>
TH-VA 250/90MM	40 bar	+600 °C	<b>250 mm</b>	7100-0012-2050-001	<b>37,26 €</b>
TH-VA 300/90MM	40 bar	+600 °C	<b>300 mm</b>	7100-0012-2060-001	<b>40,39 €</b>
Note:	inner diameter of socket 6.5mm For further information see last chapter!				
Mounting flange (Accessories)					
Type / WG01				Item No.	Price
<b>MF xx</b>					
MF-06-K	<b>Mounting flange, plastic, 56.8x84.3 mm, Ø 6.2 mm tube gland, T<sub>max</sub> +100°C</b>			7100-0030-1000-000	<b>6,55 €</b>
Note:	For information see last chapter!				