

Screw-in temperature sensors / smoke gas temperature sensors with neck tube and passive output

RGTF 2
standard

Screw-in resistance thermometer / smoke gas temperature sensor with neck tube
THERMASGARD® RGTF 2 with passive output, with connecting head made from aluminium (optionally with **cable gland** or **M12 connector** according to DIN EN 61076-2-101) and straight protective tube.

The duct sensor is used to detect relatively high temperatures in liquid or gaseous media, eg, for exhaust air and smoke gas temperature measurement..

TECHNICAL DATA

Measuring range:	-35...+600 °C (extended range limits from -100...+750 °C optional)
Sensor / output:	Pt100/Pt1000 (according to DIN EN 60 751, class B) (Perfect Sensor Protection)
Connection type:	2-wire connection (Pt1000) 4-wire connection (Pt100; optional Pt1000)
Testing current:	< 0.6 mA (Pt1000) < 1.0 mA (Pt100)
Insulating resistance:	≥ 100 MΩ, at +20 °C (500 V DC)
Electrical connection:	0.14 - 2.5 mm ² via terminal screws on ceramic base
Cable connection:	RGTF 2 (Standard) adjusting screw made of metal (M20 x 1.5); RGTF 2-KV (optional) cable gland , brass, nickel-plated (M20 x 1.5; with strain relief, exchangeable, inner diameter 6 - 12 mm) RGTF 2-Q (optional) M12 connector according to DIN EN 61076-2-101 (male, 5-pin, A-code)
Dimensions:	see dimensional drawing
Connecting head:	form B, material aluminium, colour white aluminium (similar to RAL 9006), ambient temperature -20...+100 °C
Protective tube:	stainless steel V4A (1.4571), G ½" straight pipe thread, wrench size 27 mm, p _{max} = 40 bar, Ø = 8 mm length of neck tube (HL) = 80 mm inserted length (EL) = 100 - 500 mm (see table)
Process connection:	screwed socket with G ½" straight pipe thread
Humidity:	< 95 % RH, non-precipitating air
Protection class:	III (according to EN 60 730)
Protection type:	IP 54 (according to EN 60 529) RGTF 2 IP 65 (according to EN 60 529) RGTF 2-KV / RGTF 2-Q



RGTF 2
Measuring insert with
ceramic tubelet



S+S REGELTECHNIK

THERMASGARD® RGTF 2

Screw-in temperature sensors / smoke gas temperature sensors
with neck tube and passive output

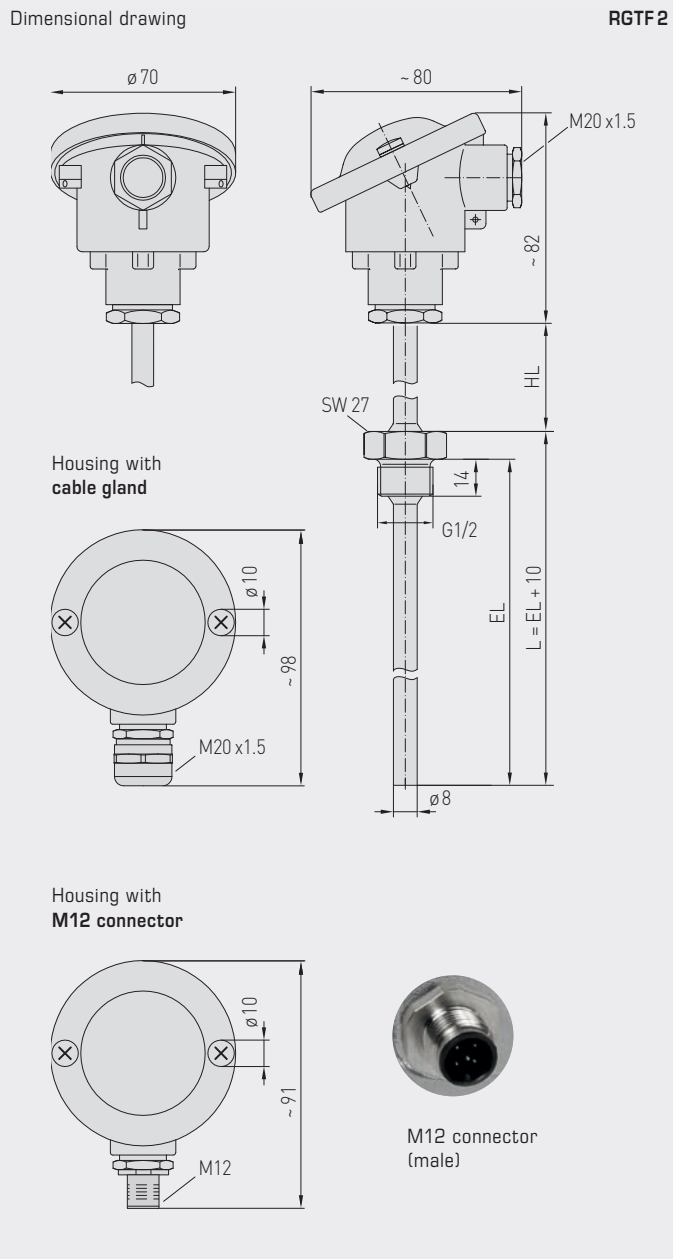
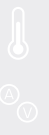

RGTF 2
standard
(IP 54)



RGTF 2-KV
with cable gland
(IP 65)



RGTF 2-Q
with M12 connector
(IP 65)



High-performance encapsulation against
vibration, mechanical stress and humidity

PS-PROTECTION
PERFECT SENSOR PROTECTION

Screw-in temperature sensors / smoke gas temperature sensors
with neck tube and passive output

2-wire connection
(Pt1000)



4-wire connection
(Pt100 / Pt1000 optional)



1x two-wire connection
(Pt1000)

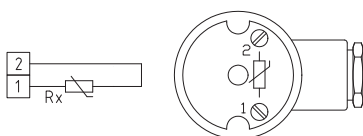

1x four-wire connection
(Pt100 / Pt1000 optional)

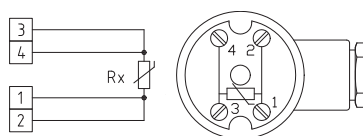

1x two-wire connection
pin assignment (M12)

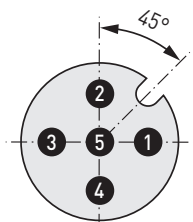

- 1 Rx
- 2 Rx
- 3 frei / free
- 4 frei / free
- 5 frei / free

1x four-wire connection
pin assignment (M12)

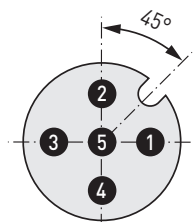

- 1 Rx
- 2 Rx
- 3 Rx
- 4 Rx
- 5 frei / free



S+S REGELTECHNIK

THERMASGARD® RGTF 2

Screw-in temperature sensors / smoke gas temperature sensors
with neck tube and passive output

RGTF2
standard
(IP 54)



THERMASGARD® RGTF 2		Screw-in temperature sensors / smoke gas temperature sensors with neck tube (standard)		
Type / WG01	Sensor / Output	Installation length (EL)	Item No.	Price
RGTF2 Pt100 xx	Pt100 (according to DIN EN 60751, class B)		IP 54, 4-wire	
RGTF2 Pt100 100/80mm	Pt100	100 mm	1101-2090-1023-000	219,43 €
RGTF2 Pt100 150/80mm	Pt100	150 mm	1101-2090-1033-000	220,65 €
RGTF2 Pt100 200/80mm	Pt100	200 mm	1101-2090-1043-000	227,46 €
RGTF2 Pt100 250/80mm	Pt100	250 mm	1101-2090-1053-000	222,28 €
RGTF2 Pt100 300/80mm	Pt100	300 mm	1101-2090-1063-000	238,38 €
RGTF2 Pt100 500/80mm	Pt100	500 mm	1101-2090-1103-000	253,39 €
RGTF2 Pt1000 xx	Pt1000 (according to DIN EN 60751, class B)		IP 54, 2-wire	
RGTF2 Pt1000 100/80	Pt1000	100 mm	1101-2090-5021-000	212,73 €
RGTF2 Pt1000 150/80	Pt1000	150 mm	1101-2090-5031-000	214,10 €
RGTF2 Pt1000 200/80	Pt1000	200 mm	1101-2090-5041-000	220,93 €
RGTF2 Pt1000 250/80	Pt1000	250 mm	1101-2090-5051-000	222,29 €
RGTF2 Pt1000 300/80	Pt1000	300 mm	1101-2090-5061-000	231,82 €
RGTF2 Pt1000 500/80	Pt1000	500 mm	1101-2090-5101-000	246,82 €
Housing variant:	equipped as standard with pressure screw (IP 54), optional housing variants with cable gland (IP 65) or M12 connector (IP 65) see the next page!			
Extra charge:	other measuring ranges optional			on request

Screw-in temperature sensors / smoke gas temperature sensors
with neck tube and passive output

RGTF2 - Q
with M12 connector
(IP65)



THERMASGARD® RGTF 2 - Q		Screw-in temperature sensors / smoke gas temperature sensors with neck tube (with M12 connector)			
Type / WG03	Sensor / Output	Installation length (EL)	Q	Item No.	Price
RGTF2 Pt100 xx Q	Pt100 (according to DIN EN 60751, class B)		●	IP 65, 4-wire	
RGTF2 Pt100 100/80mm Q	Pt100	100 mm	●	2Z01-4141-0100-011	257,64 €
RGTF2 Pt100 150/80mm Q	Pt100	150 mm	●	2Z01-4141-0100-021	259,00 €
RGTF2 Pt100 200/80mm Q	Pt100	200 mm	●	2Z01-4141-0100-031	265,82 €
RGTF2 Pt100 250/80mm Q	Pt100	250 mm	●	2Z01-4141-0100-041	267,19 €
RGTF2 Pt100 300/80mm Q	Pt100	300 mm	●	2Z01-4141-0100-051	276,72 €
RGTF2 Pt100 500/80mm Q	Pt100	500 mm	●	2Z01-4141-0100-061	291,73 €
RGTF2 Pt1000 xx Q	Pt1000 (according to DIN EN 60751, class B)			IP 65, 2-wire	
RGTF2 Pt1000 100/80mm Q	Pt1000	100 mm	●	2Z05-4141-0100-011	257,64 €
RGTF2 Pt1000 150/80mm Q	Pt1000	150 mm	●	2Z05-4141-0100-021	259,00 €
RGTF2 Pt1000 200/80mm Q	Pt1000	200 mm	●	2Z05-4141-0100-031	265,82 €
RGTF2 Pt1000 250/80mm Q	Pt1000	250 mm	●	2Z05-4141-0100-041	267,19 €
RGTF2 Pt1000 300/80mm Q	Pt1000	300 mm	●	2Z05-4141-0100-051	276,72 €
RGTF2 Pt1000 500/80mm Q	Pt1000	500 mm	●	2Z05-4141-0100-061	291,73 €
Housing variant "Q":	Cable connection with M12 connector (male, 5-pin, A-code)				
Extra charge:	other measuring ranges optional			on request	

ACCESSORIES

Special accessories for M12 connector
see chapter Accessories!

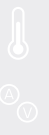
RGTF2 - KV
with cable gland
(IP 65)

THERMASGARD® RGTF 2 - KV		Screw-in temperature sensors / smoke gas temperature sensors with neck tube (with cable gland)		
Type / WG01	Sensor / Output	Installation length (EL)	Item No.	Price
RGTF2 Pt100 xx KV	Pt100 (according to DIN EN 60751, class B)		IP 65, 4-wire	
RGTF2 Pt100 100/80mm KV	Pt100	100 mm	1101-20D0-1023-000	222,85 €
RGTF2 Pt100 150/80mm KV	Pt100	150 mm	1101-20D0-1033-000	224,21 €
RGTF2 Pt100 200/80mm KV	Pt100	200 mm	1101-20D0-1043-000	231,04 €
RGTF2 Pt100 250/80mm KV	Pt100	250 mm	1101-20D0-1053-000	232,38 €
RGTF2 Pt100 300/80mm KV	Pt100	300 mm	1101-20D0-1063-000	241,92 €
RGTF2 Pt100 500/80mm KV	Pt100	500 mm	1101-20D0-1103-000	256,94 €
RGTF2 Pt1000 xx KV	Pt1000 (according to DIN EN 60751, class B)		IP 65, 2-wire	
RGTF2 Pt1000 100/80mm KV	Pt1000	100 mm	1101-20D0-5021-000	222,85 €
RGTF2 Pt1000 150/80mm KV	Pt1000	150 mm	1101-20D0-5031-000	224,21 €
RGTF2 Pt1000 200/80mm KV	Pt1000	200 mm	1101-20D0-5041-000	231,04 €
RGTF2 Pt1000 250/80mm KV	Pt1000	250 mm	1101-20D0-5051-000	232,38 €
RGTF2 Pt1000 300/80mm KV	Pt1000	300 mm	1101-20D0-5061-000	241,92 €
RGTF2 Pt1000 500/80mm KV	Pt1000	500 mm	1101-20D0-5101-000	256,94 €
Housing variant "KV":	Cable connection with cable gland			
Extra charge:	other measuring ranges optional			on request