

Duct humidity and temperature sensors ($\pm 1.8\%$ / $\pm 2.0\%$), including mounting flange, calibratable, with multi-range switching and active/passive output

Calibratable duct humidity-/temperature sensor **HYGRASGARD® KFF-SD/KFTF-SD** ($\pm 2,0\%$), with plastic sinter filter (optional metal sinter filter), housing made from impact-resistant plastic with snap-on lid, with cable gland (optional M12 connector according to DIN EN 61076-2-101).

Calibratable duct humidity-/temperature sensor **HYGRASGARD® KFF/KFTF** ($\pm 2,0\%$) or **KFF-20/KFTF-20** ($\pm 1,8\%$), with plastic sinter filter (optional metal sinter filter), housing made of impact-resistant plastic with quick-locking screws, optionally with/without display, with cable gland (optional M12 connector according to DIN EN 61076-2-101).

It measures the relative humidity and/or the temperature of the air and converts the measurands into a standard signal of 0-10V or 4...20mA. It has four switchable temperature ranges and is applied in non-aggressive dust-free atmospheres in refrigeration, air conditioning, ventilation and clean room technology. These measuring transducers are designed for exact detection of humidity. A digital long-term stable sensor is used as measuring element for humidity measurement. The sensor is factory-calibrated; an environmental precision adjustment by an expert is possible.

TECHNICAL DATA

Power supply:	24 V AC ($\pm 20\%$); 15...36 V DC for U variant 15...36 V DC for I variant, depending on working resistance, residual ripple stabilised $\pm 0.3V$
Working resistance:	$R_b(\text{ohm}) = (U_b - 14V) / 0.02A$ for I variant, see load resistance diagram
Load resistance:	$R_L > 5k\Omega$ hm for U variant
Power consumption:	$< 1.1 VA / 24V DC$; $< 2.2 VA / 24V AC$
Sensors:	digital humidity sensor with integrated temperature sensor , low hysteresis, high long-term stability
HUMIDITY	
Measuring range, humidity:	0...100% RH
Permissible air humidity:	$< 95\%$ RH, non-precipitating air
Accuracy, humidity:	KFF / KFTF / KFF-SD / KFTF-SD: typically $\pm 2.0\%$ (20...80% RH) at $+25^\circ C$, otherwise $\pm 3.0\%$ KFF-20 / KFTF-20: typically $\pm 1.8\%$ (10...90% RH) at $+25^\circ C$, otherwise $\pm 2.0\%$
Output, humidity:	0-10 V for U variant; 4...20 mA for I variant
TEMPERATURE	
Measuring range, temperature:	multi-range switching with 4 switchable measuring ranges (see table) $-35...+35^\circ C$; $-35...+75^\circ C$; $0...+50^\circ C$; $0...+80^\circ C$
Ambient temperature:	storage $-35...+85^\circ C$; operation $-30...+75^\circ C$, non-precipitating
Accuracy, temperature:	typically $\pm 0.2K$ at $+25^\circ C$
Output, temperature:	0-10 V for U variant; 4...20 mA for I variant; KFTF-Uxx (passive temperature sensor) see table
Electrical connection:	2-, 3-, or 4-wire connection (see connecting diagram), 0.14 - 1.5 mm ² , via terminal screws
Cable connection:	cable gland , plastic (M 16 x 1.5; with strain relief, exchangeable, max. inner diameter 10.4 mm) or M12 connector according to DIN EN 61076-2-101 (optional)
Housing:	plastic, UV-resistant, material polyamide, 30% glass-globe reinforced, with quick-locking screws (slotted / Phillips head combination), colour traffic white (similar to RAL 9016), housing cover for display is transparent!
Housing dimensions:	KFF-xx / KFTF-xx (without display): 72 x 64 x 37.8 mm (Tyr 1/01) KFF / KFTF (with display): 72 x 64 x 43.3 mm (Tyr 1) KFF-20 / KFTF-20 (with display): 26 x 90 x 50 mm (Tyr 2)
Protective tube:	PLEUROFORM™ , material polyamide (PA6), with torsion protection $\varnothing 20$ mm, NL = 235 mm (optionally 100 mm), $v_{max} = 30$ m/s (air) (on request, optional stainless steel V2A (1.4301), $\varnothing 16$ mm)
Sensor protection:	plastic sinter filter , $\varnothing 16$ mm, L = 35 mm, exchangeable (optional metal sinter filter , $\varnothing 16$ mm, L = 32 mm)
Process connection:	by mounting flange, plastic (included in the scope of delivery)
Long-term stability:	$\pm 1\%$ per year
Protection class:	III (according to EN 60 730)
Protection type:	KFF-SD / KFTF-SD IP 54 (according to EN 60 529) Housing tested, TÜV SÜD, Report No. 713160960A (Tyr 01) KFF-xx / KFTF-xx IP 65 (according to EN 60 529) Housing tested, TÜV SÜD, Report No. 713139052 (Tyr 1)
Standards:	CE conformity, according to EMC directive 2014 / 30 / EU, according to EN 61326-1, according to EN 61326-2-3
Optional:	display with illumination , for displaying ACTUAL temperature and / or ACTUAL humidity KFF / KFTF (Tyr 1): two-line, cutout approx. 36x15 mm (W x H) KFF-20 / KFTF-20 (Tyr 2): three-line, cutout approx. 70x40 mm (W x H)
ACCESSORIES	see last chapter

SF-K
Plastic sinter filter (standard)



SF-M
Metal sinter filter (optional)



Protective tube stainless steel (optional on request)



M12 connector (optional)

MFT-20-K
Mounting flange, plastic



Dimensional drawing (mm) **MFT-20-K**

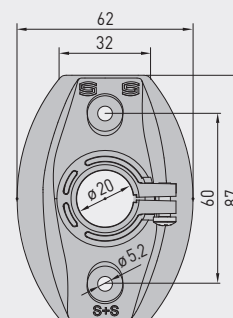
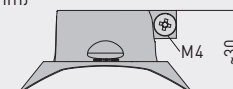



Dimensional drawing
[mm]

without display

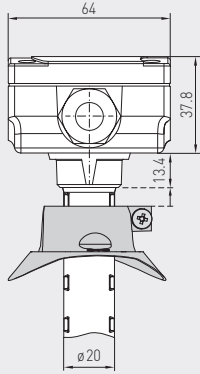

with display

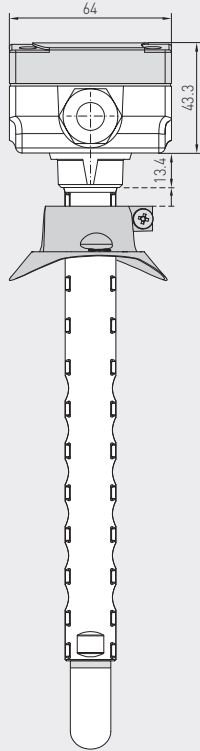

KFF/KFTF with/without display
KFF-SD/KFTF-SD without display
KFF-20/KFTF-20 without display

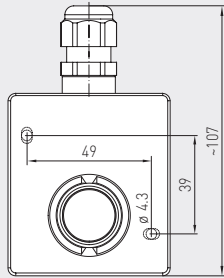
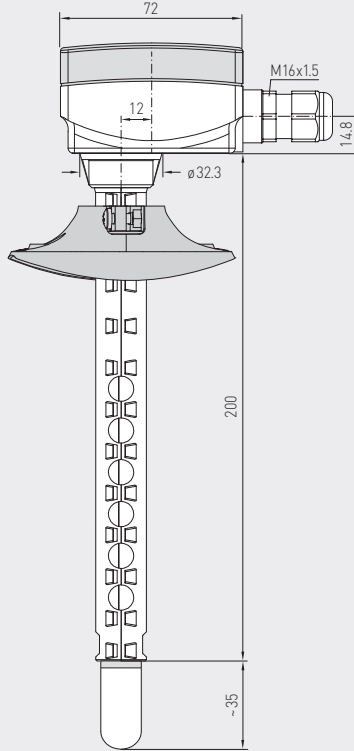

KFF-SD/KFTF-SD ($\pm 2.0\%$)
with snap-on lid
(IP54)



KFF/KFTF ($\pm 2.0\%$)
KFF-20/KFTF-20 ($\pm 1.8\%$)
without display
(IP65)

Dimensional drawing
[mm]

KFF-20/KFTF-20 with display

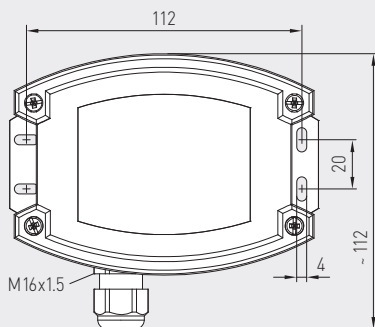
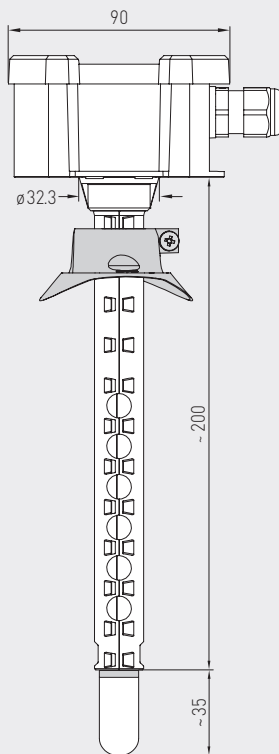
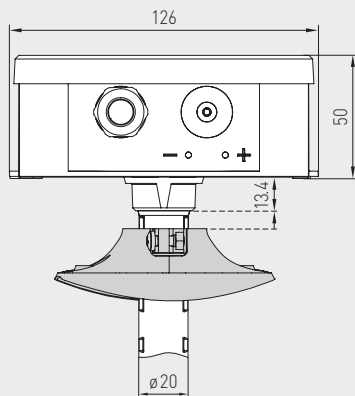

KFF/KFTF ($\pm 2.0\%$)
with display
(IP65)



KFF-20/KFTF-20 ($\pm 1.8\%$)
with display
(IP65)

Duct humidity and temperature sensors ($\pm 1.8\%$ / $\pm 2.0\%$), including mounting flange, calibratable, with multi-range switching and active/passive output

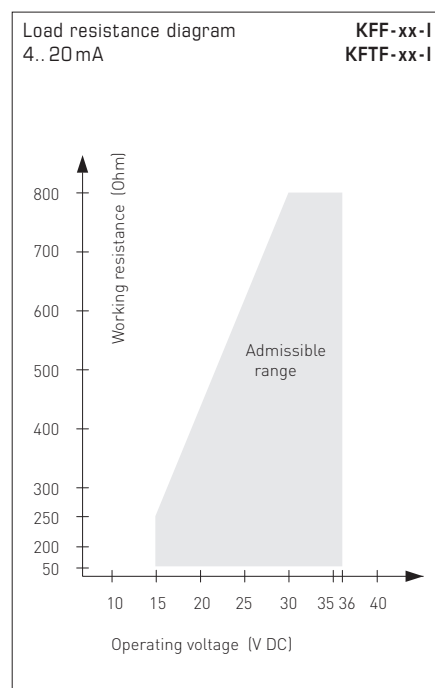
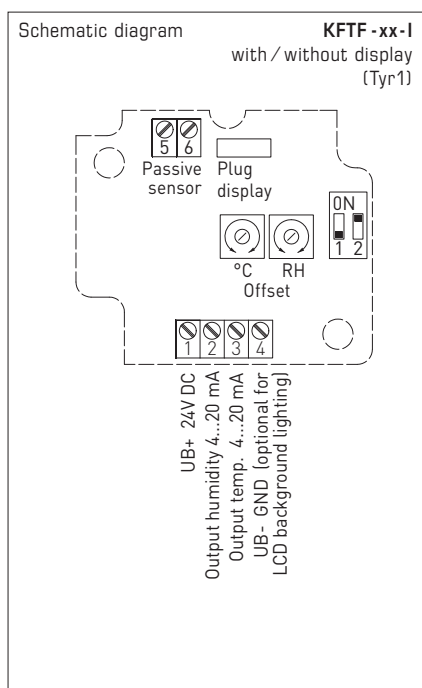
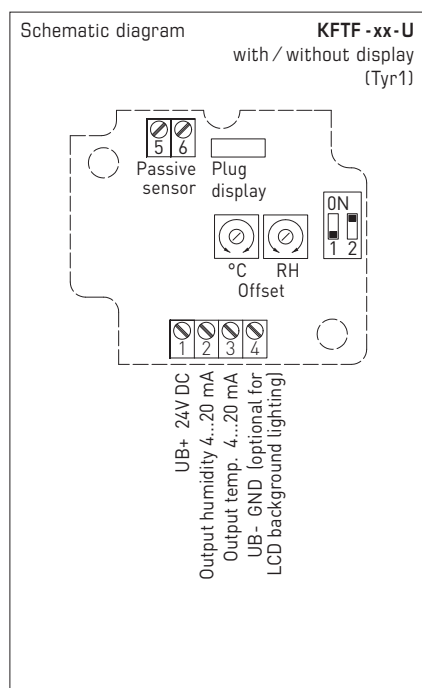
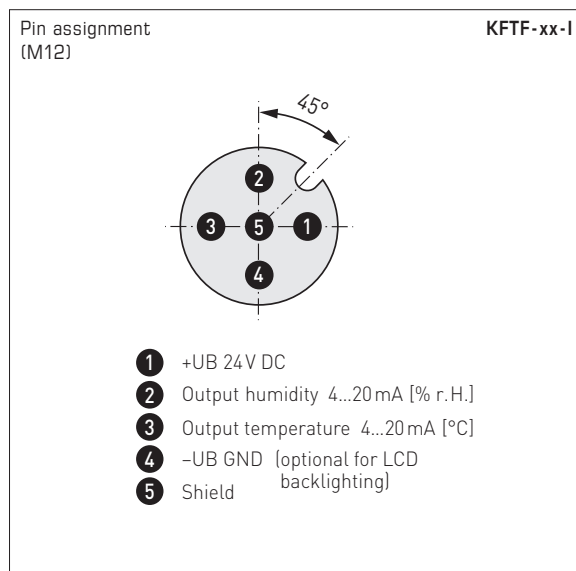
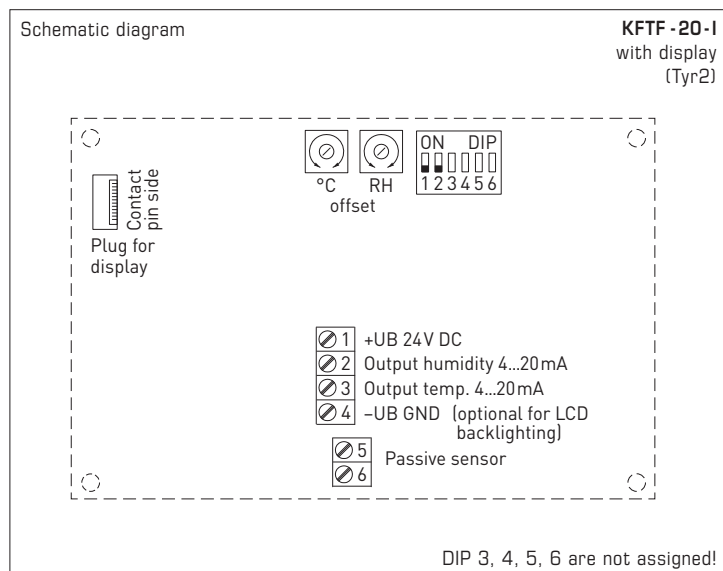
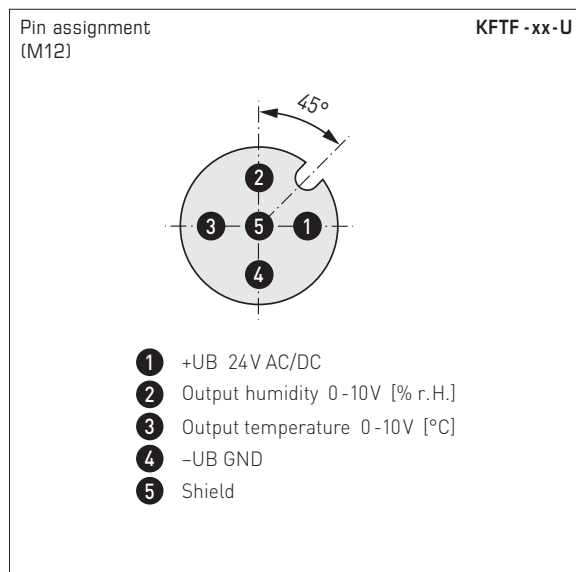
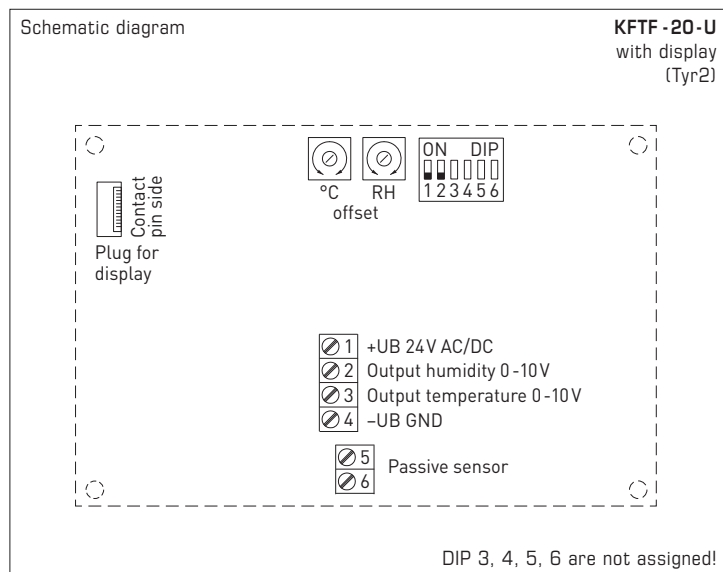



S+S REGELTECHNIK

HYGRASGARD® KFF-xx
HYGRASGARD® KFTF-xx

Duct humidity and temperature sensors ($\pm 1.8\%$ / $\pm 2.0\%$),
including mounting flange, calibratable, with multi-range switching
and active/passive output

3-wire connection **KFF-xx-U**

1	+UB 24V AC/DC
2	Output humidity 0-10V
3	Free
4	-UB-GND

2- or 3-wire connection * **KFF-xx-I (Transmitter)**

1	+UB 24V DC
2	Output humidity 4...20mA
3	Free
4	-UB-GND (optional for backlighting)

4- or 6-wire connection **KFTF-U (passive temperature sensor)**

1	+UB 24V AC/DC
2	Output humidity 0-10V
3	Output temperature 0-10V
4	-UB-GND
5	Passive element
6	e.g. Pt1000, Ni1000, LMZ235Z

4-wire connection **KFTF-xx-U**

1	+UB 24V AC/DC
2	Output humidity 0-10V
3	Output temperature 0-10V
4	-UB-GND

3- or 4-wire connection ** **KFTF-xx-I (Transmitter)**

1	+UB 24V DC
2	Output humidity 4...20mA
3	Output temp. 4...20mA
4	-UB-GND (optional for backlighting)

4- or 6-wire connection **KFTF-I (passive temperature sensor)**

1	+UB 24V DC
2	Output humidity 4...20mA
3	Output temp. 4...20mA
4	-UB-GND (optional for backlighting)
5	Passive element
6	e.g. Pt1000, Ni1000, LMZ235Z

Temperature measuring ranges (adjustable)	DIP 1	DIP 2
-35...+75 °C	ON	ON
-35...+35 °C	OFF	OFF
0...+50 °C (default)	OFF	ON
0...+80 °C	ON	OFF

Connection*:
2-wire connection for devices with/without display (not illuminated)
3-wire connection for devices with illuminated display

Connection**:
3-wire connection for devices with/without display (not illuminated)
4-wire connection for devices with illuminated display

For the **I variant** the humidity path must be connected!

Temperature table
MR: -35...+75 °C

°C	U _A [V]	I _A [mA]
-35	0.0	4.0
-30	0.5	4.7
-25	0.9	5.5
-20	1.4	6.2
-15	1.8	6.9
-10	2.3	7.6
-5	2.7	8.4
0	3.2	9.1
5	3.6	9.8
10	4.1	10.5
15	4.5	11.3
20	5.0	12.0
25	5.5	12.7
30	5.9	13.5
35	6.4	14.2
40	6.8	14.9
45	7.3	15.6
50	7.7	16.4
55	8.2	17.1
60	8.6	17.8
65	9.1	18.5
70	9.5	19.2
75	10.0	20.0

Temperature table
MR: -35...+35 °C

°C	U _A [V]	I _A [mA]
-35	0.0	4.0
-30	0.7	5.1
-25	1.4	6.3
-20	2.1	7.4
-15	2.9	8.6
-10	3.6	9.7
-5	4.3	10.9
0	5.0	12.0
5	5.7	13.1
10	6.4	14.3
15	7.1	15.4
20	7.9	16.6
25	8.6	17.7
30	9.3	18.9
35	10.0	20.0

Temperature table
MR: 0...+50 °C

°C	U _A [V]	I _A [mA]
0	0.0	4.0
5	1.0	5.6
10	2.0	7.2
15	3.0	8.8
20	4.0	10.4
25	5.0	12.0
30	6.0	13.6
35	7.0	15.2
40	8.0	16.8
45	9.0	18.4
50	10.0	20.0

Temperature table
MR: 0...+80 °C

°C	U _A [V]	I _A [mA]
0	0.0	4.0
5	0.6	5.0
10	1.3	6.0
15	1.9	7.0
20	2.5	8.0
25	3.1	9.0
30	3.8	10.0
35	4.4	11.0
40	5.0	12.0
45	5.6	13.0
50	6.3	14.0
55	6.9	15.0
60	7.5	16.0
65	8.1	17.0
70	8.8	18.0
75	9.4	19.0
80	10.0	20.0

Humidity table
MR: 0...100% RH

% RH	U _A [V]	I _A [mA]
0	0.0	4.0
5	0.5	4.8
10	1.0	5.6
15	1.5	6.4
20	2.0	7.2
25	2.5	8.0
30	3.0	8.8
35	3.5	9.6
40	4.0	10.4
45	4.5	11.2
50	5.0	12.0
55	5.5	12.8
60	6.0	13.6
65	6.5	14.4
70	7.0	15.2
75	7.5	16.0
80	8.0	16.8
85	8.5	17.6
90	9.0	18.4
95	9.5	19.2
100	10.0	20.0

Duct humidity and temperature sensors ($\pm 2.0\%$), including mounting flange, calibratable, with multi-range switching and active output

KFF-SD / KFTF-SD
with snap-on lid
(IP 54)



HYGRASGARD® KFF -SD Duct humidity sensors ($\pm 2.0\%$), *Standard*
HYGRASGARD® KFTF -SD Duct humidity and temperature sensors ($\pm 2.0\%$), *Standard*

Type / WG01B	Measuring Range / Readout		Output		Item No.	Price
	Humidity	Temperature	Humidity	Temperature		
KFF-SD					IP 54	
KFF-SD-I	0...100% RH	-	4...20 mA	-	1201-3182-0000-029	173,87 €
KFF-SD-U	0...100% RH	-	0-10V	-	1201-3181-0000-029	173,87 €
KFTF-SD					IP 54	
KFTF-SD-I	0...100% RH	-35...+75 °C -35...+35 °C 0...+50 °C 0...+80 °C	4...20 mA	4...20 mA	1201-3182-1000-029	178,63 €
KFTF-SD-U	0...100% RH	(4x as above)	0-10V	0-10V	1201-3181-1000-029	178,63 €
Optional:	Cable connection with M12 connector according to DIN EN 61076-2-101 shortened protective tube PLEUROFORM™ , NL = 100 mm				on request	on request

ACCESSORIES

SF-M	Metal sinter filter , \varnothing 16 mm, L = 32 mm, exchangeable stainless steel V4A (1.4404)	7000-0050-2200-100	45,34 €
-------------	---	--------------------	----------------

For further information, see chapter Accessories!



S+S REGELTECHNIK

HYGRASGARD® KFF
HYGRASGARD® KFTF

Duct humidity and temperature sensors ($\pm 2.0\%$),
including mounting flange, calibratable, with multi-range switching
and active/passive output

KFF / KFTF
with quick-locking screws
(IP65)



HYGRASGARD® KFF		Duct humidity sensors ($\pm 2.0\%$), <i>Standard</i>				Display	Item No.	Price
HYGRASGARD® KFTF		Duct humidity and temperature sensors ($\pm 2.0\%$), <i>Standard</i>						
Type / WG01	Measuring Range / Readout		Output		Temperature			
	Humidity	Temperature	Humidity	Temperature				
KFF						IP65		
KFF-I	0...100% RH	–	4...20 mA	–			1201-3112-0000-029	186,83 €
KFF-I LCD	0...100% RH	–	4...20 mA	–		■	1201-3112-0200-029	241,37 €
KFF-U	0...100% RH	–	0-10 V	–			1201-3111-0000-029	186,83 €
KFF-U LCD	0...100% RH	–	0-10 V	–		■	1201-3111-0200-029	241,37 €
KFTF						IP65		
KFTF-I	0...100% RH	–35...+75 °C –35...+35 °C 0...+50 °C 0...+80 °C	4...20 mA	4...20 mA			1201-3112-1000-029	191,60 €
KFTF-I LCD	0...100% RH	(4x as above)	4...20 mA	4...20 mA		■	1201-3112-1200-029	246,15 €
KFTF-U	0...100% RH	–35...+75 °C –35...+35 °C 0...+50 °C 0...+80 °C	0-10 V	0-10 V			1201-3111-1000-029	191,60 €
KFTF-U LCD	0...100% RH	(4x as above)	0-10 V	0-10 V		■	1201-3111-1200-029	246,15 €
Optional:	Cable connection with M12 connector according to DIN EN 61076-2-101 shortened protective tube PLEUROFORM™ , NL = 100 mm						on request	on request

HYGRASGARD® KFTF - U xx		Duct humidity and temperature sensors ($\pm 2.0\%$), <i>Standard</i> (passive temperature sensor)				Item No.	Price	
Type / WG01	Measuring Range / Readout		Output		Temperature			
	Humidity	Temperature	Humidity	Temperature				
KFTF - U xx	Pt, Ni, LM235Z, NTC				(active / passive)	IP65		
KFTF-U Pt100	0...100% RH	–35...+75 °C –35...+35 °C 0...+50 °C 0...+80 °C	0-10 V	0-10 V + Pt100			1201-3111-2001-029	199,10 €
KFTF-U Pt1000	0...100% RH	(4x as above)	0-10 V	0-10 V + Pt1000			1201-3111-2005-029	199,78 €
KFTF-U Ni1000	0...100% RH	(4x as above)	0-10 V	0-10 V + Ni1000			1201-3111-2009-029	200,46 €
KFTF-U NiTK	0...100% RH	(4x as above)	0-10 V	0-10 V + Ni1000TK5000			1201-3111-2010-029	201,54 €
KFTF-U LM235Z	0...100% RH	(4x as above)	0-10 V	0-10 V + LM235Z , 10mV/K			1201-3111-2021-029	200,19 €
KFTF-U NTC1,8K	0...100% RH	(4x as above)	0-10 V	0-10 V + NTC 1,8 kOhm			1201-3111-2012-029	200,46 €
KFTF-U NTC10K	0...100% RH	(4x as above)	0-10 V	0-10 V + NTC 10 kOhm			1201-3111-2015-029	199,23 €
KFTF-U NTC20K	0...100% RH	(4x as above)	0-10 V	0-10 V + NTC 20 kOhm			1201-3111-2016-029	199,23 €
Optional:	Cable connection with M12 connector according to DIN EN 61076-2-101 shortened protective tube PLEUROFORM™ , NL = 100 mm						on request	on request

Duct humidity and temperature sensors ($\pm 1.8\%$),
incl. mounting flange, calibratable, with multi-range switching
and active output

KFTF-20-Q

with M12 connector,
with display (Tyr2)



KFTF-20-Q

with M12 connector,
without display (Tyr1)



HYGRASGARD® KFTF-20-Q		Duct humidity and temperature sensors ($\pm 1.8\%$), <i>Premium</i> (with M12 connector)					
Type / WG02	Measuring Range / Readout Humidity	Temperature	Output Humidity	Temperature	Display ● = Q	Item No.	Price
KFTF-20-Q						IP 65	
KFTF-20-I Q	0...100% RH	-35...+75 °C -35...+35 °C 0...+50 °C 0...+80 °C	4... 20 mA	4... 20 mA	●	2003-4151-2100-001	328,60 €
KFTF-20-I Q LCD	0...100% RH	(4x as above)	4... 20 mA	4... 20 mA	● ■	2003-4172-2100-001	380,41 €
KFTF-20-U Q	0...100% RH	-35...+75 °C -35...+35 °C 0...+50 °C 0...+80 °C	0-10V	0-10V	●	2003-4151-1100-001	328,60 €
KFTF-20-U Q LCD	0...100% RH	(4x as above)	0-10V	0-10V	● ■	2003-4172-1100-001	380,41 €
Housing variant "Q":		Cable connection with M12 connector (male, 5-pin, A-code)					

ACCESSORIES			
SF-M	Metal sinter filter, \varnothing 16 mm, L = 32 mm, exchangeable stainless steel V4A (1.4404)	7000-0050-2200-100	45,34 €
For further information, see chapter Accessories!			



S+S REGELTECHNIK

HYGRASGARD® KFF-20
HYGRASGARD® KFTF-20

Duct humidity and temperature sensors ($\pm 1.8\%$),
incl. mounting flange, calibratable, with multi-range switching
and active output

KFF-20 / KFTF-20

with cable gland,
with display (Tyr2)



KFF-20 / KFTF-20

with cable gland,
without display (Tyr1)



HYGRASGARD® KFF-20		Duct humidity sensors ($\pm 1.8\%$), <i>Premium</i> (with cable gland)					
Type / WG02	Measuring Range / Readout Humidity	Readout Temperature	Output Humidity	Temperature	Display	Item No.	Price
KFF-20						IP65	
KFF-20-I	0...100% RH	-	4... 20mA	-		1201-3112-0000-030	258,42 €
KFF-20-I LCD	0...100% RH	-	4... 20mA	-	■	1201-8112-0400-030	312,96 €
KFF-20-U	0...100% RH	-	0-10V	-		1201-3111-0000-030	258,42 €
KFF-20-U LCD	0...100% RH	-	0-10V	-	■	1201-8111-0400-030	312,96 €
Housing variant:	Cable connection with cable gland (M12 connector on request)						

HYGRASGARD® KFTF-20		Duct humidity and temperature sensors ($\pm 1.8\%$), <i>Premium</i> (with cable gland)					
Type / WG02	Measuring Range / Readout Humidity	Readout Temperature	Output Humidity	Temperature	Display	Item No.	Price
KFTF-20						IP65	
KFTF-20-I	0...100% RH	-35...+75 °C -35...+35 °C 0...+50 °C 0...+80 °C	4... 20mA	4... 20mA		1201-3112-1000-030	283,68 €
KFTF-20-I LCD	0...100% RH	(4x as above)	4... 20mA	4... 20mA	■	1201-8112-1400-030	335,52 €
KFTF-20-U	0...100% RH	-35...+75 °C -35...+35 °C 0...+50 °C 0...+80 °C	0-10V	0-10V		1201-3111-1000-030	283,68 €
KFTF-20-U LCD	0...100% RH	(4x as above)	0-10V	0-10V	■	1201-8111-1400-030	335,52 €
Housing variant:	Cable connection with cable gland (M12 connector see KFTF-20-Q)						

ACCESSORIES								
SF-M	Metal sinter filter, \varnothing 16 mm, L=32 mm, exchangeable stainless steel V4A (1.4404)						7000-0050-2200-100	45,34 €
For further information, see chapter Accessories!								