

**On-wall humidity sensors and temperature sensors (± 1.8%),
calibratable, with multi-range switching
and active output**

Calibratable outdoor humidity and temperature sensor **HYGRASGARD® AFTF-20-VA** (± 1.8%) with metal sinter filter, rugged housing, **stainless steel V4A**, optionally with /without display, with cable gland or M12 connector according to DIN EN 61076-2-101.

It measures the relative humidity and the temperature of the air and converts the measurand into a standard signal of 0 - 10 V or 4...20 mA. It has four switchable temperature ranges and is applied in non-aggressive dust-free atmospheres in refrigeration, air conditioning, ventilation and clean room technology. These measuring transducers are designed for exact detection of humidity. A digital long-term stable sensor is used as measuring element for humidity measurement. The sensor is factory-calibrated; an environmental precision adjustment by an expert is possible.

TECHNICAL DATA

Power supply:	24 V AC (± 20%); 15...36 V DC for U variant 15...36 V DC for I variant, depending on working resistance, residual ripple stabilised ± 0.3 V
Working resistance:	R_B (ohm) = $(U_b - 14 V) / 0.02 A$ for I variant, see load resistance diagram
Load resistance:	$R_L > 5 k\Omega$ for U variant
Power consumption:	< 1.1 VA / 24 V DC; < 2.2 VA / 24 V AC
Sensors:	digital humidity sensor with integrated temperature sensor, low hysteresis, high long-term stability

HUMIDITY

Measuring range, humidity:	0...100% RH
Permitted humidity:	< 95% RH, non-precipitating air
Accuracy in humidity:	typically ± 1.8% (10...90% RH) at +25 °C, otherwise ± 2.0%
Output humidity:	0 - 10 V for U variant 4...20 mA for I variant

TEMPERATURE

Measuring range, temperature:	multi-range switching (see table) -35...+35 °C; -35...+75 °C; 0...+50 °C; 0...+80 °C
Ambient temperature:	storage -35...+85 °C; operation -30...+80 °C, non-precipitating
Accuracy, temperature:	typically ± 0.2 K at +25 °C
Output, temperature:	0 - 10 V for U variant 4...20 mA for I variant
Electrical connection:	2-, 3-, or 4-wire connection (see connecting diagram), 0.14 - 1.5 mm ² , via terminal screws
Cable connection:	cable gland, stainless steel V2A (1.4305) (M20 x 1.5; with strain relief, exchangeable, inner diameter 6 - 12 mm) or M12 connector (male, 5-pin, A-code) according to DIN EN 61076-2-101
Housing:	stainless steel V4A (1.4571), with non-distortion cover bolting, impact resistant, high EMI shielding, corrosion, temperature, weather- and UV-resistant
Housing dimensions:	143 x 97 x 61 mm (Tyr 2E)
Protective tube:	made from stainless steel V2A (1.4301), Ø 16 mm, NL = 137 mm
Sensor protection:	metal sinter filter , Ø 16 mm, L = 32 mm, exchangeable, stainless steel V4A (1.4404)
Process connection:	by screws via the mounting fixture on the housing
Long-term stability:	± 1% per year
Protection class:	III (according to EN 60 730)
Protection type:	IP 65 (according to EN 60 529) Housing tested, TÜV SÜD, Report No. 713160960B (Skadi2)
Standards:	CE conformity according to EMC Directive 2014 / 30 / EU, according to EN 61326-1, according to EN 61326-2-3
Optional:	display with illumination , three-line, cutout approx. 70 x 40 mm (W x H), to display the ACTUAL temperature and ACTUAL humidity

ACCESSORIES (see table)

AFTF-20-VA
with cable gland



AFTF-20-VAQ
with M12 connector



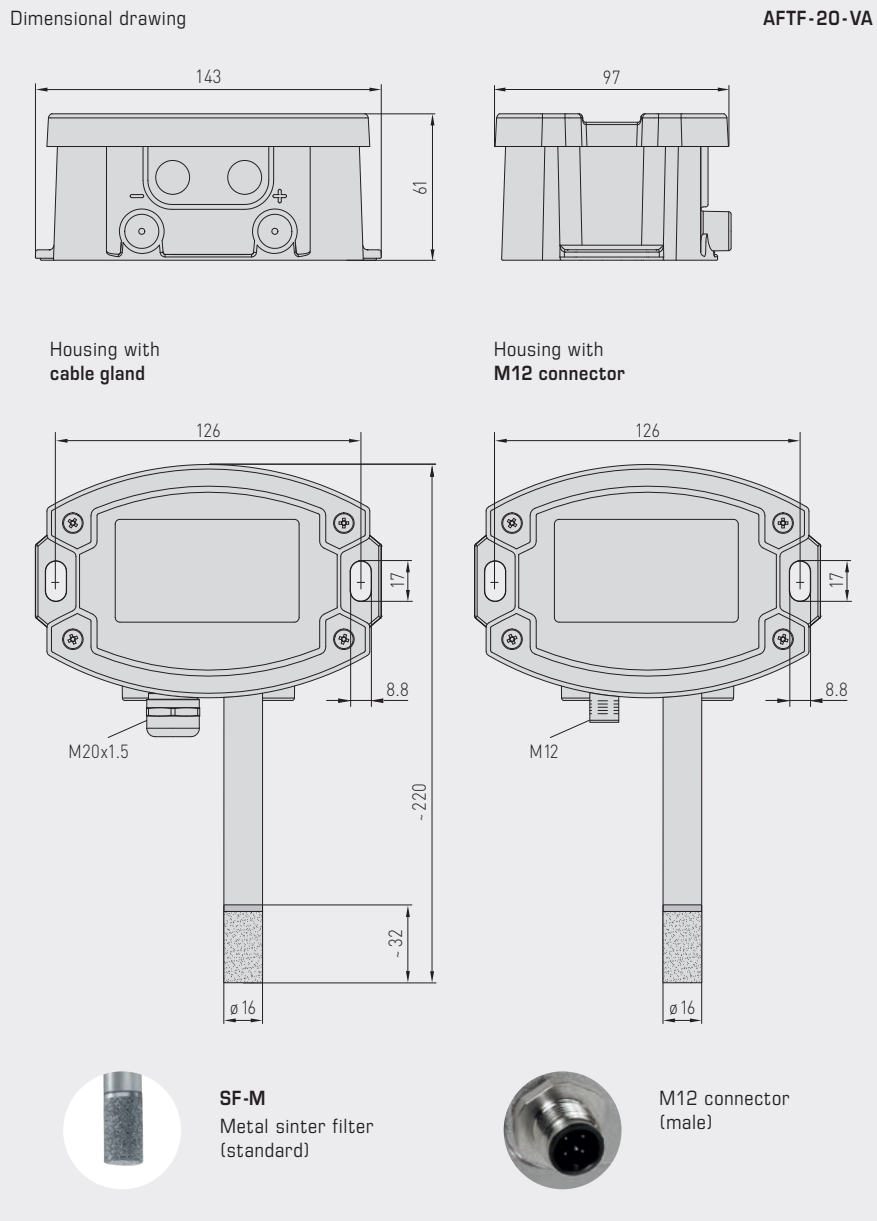

AFTF-20-VA
with cable gland
and display



AFTF-20-VAQ
with M12 connector
and display



On-wall humidity sensors and temperature sensors ($\pm 1.8\%$),
calibratable, with multi-range switching
and active output

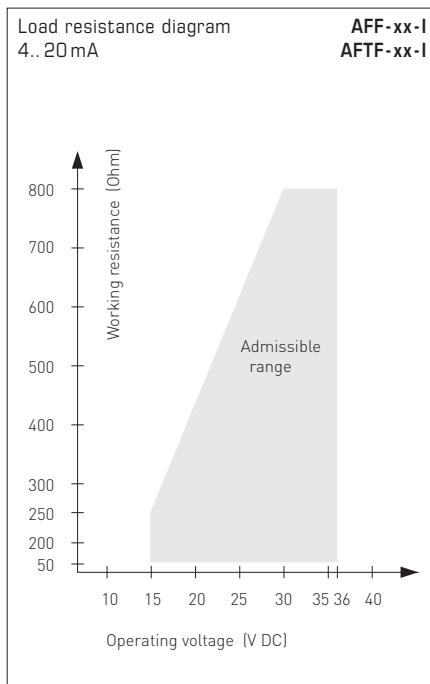
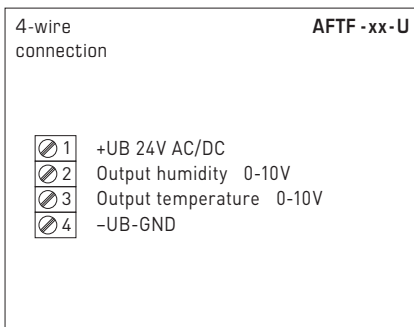
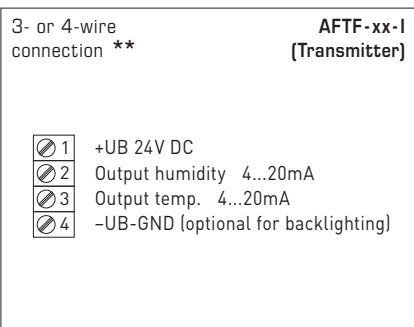
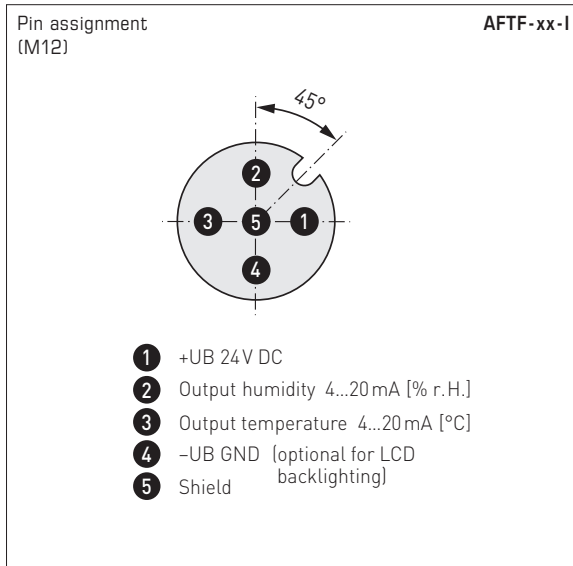
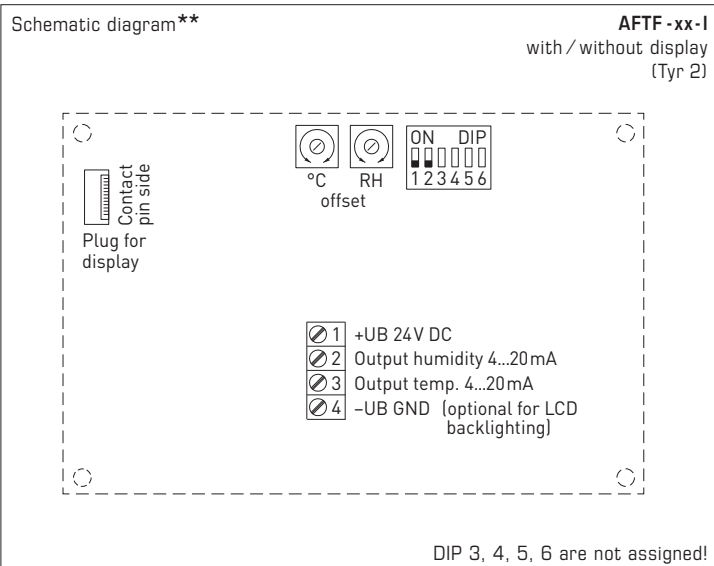
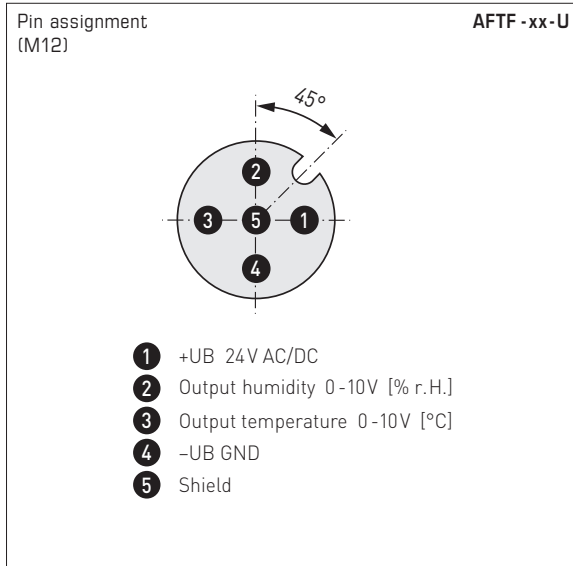
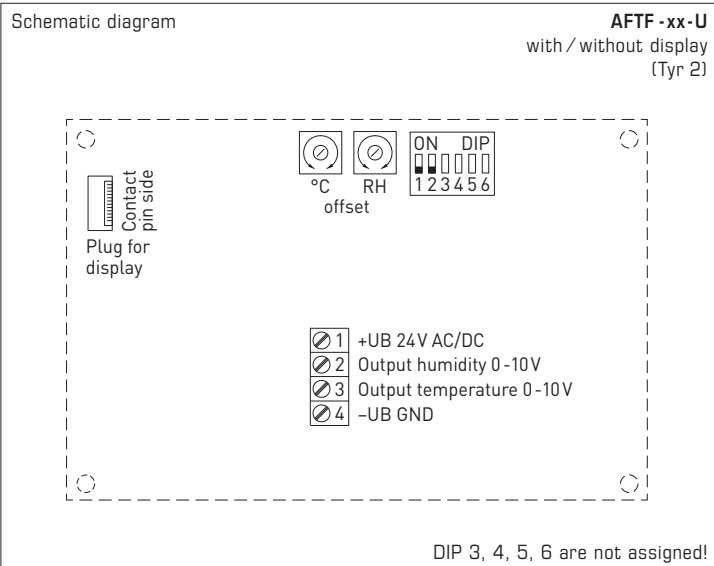

Connection**:
3-wire connection for devices with/without display (not illuminated)
4-wire connection for devices with illuminated display

For the **I** variant the humidity path must be connected!

Temperature measuring ranges (adjustable)	DIP 1	DIP 2
-35...+75 °C	ON	ON
-35...+35 °C	OFF	OFF
0...+50 °C (default)	OFF	ON
0...+80 °C	ON	OFF



AFTF-20-VAQ
with display,
hinged



Temperature table
MR: -35...+75 °C

°C	U _A [V]	I _A [mA]
-35	0.0	4.0
-30	0.5	4.7
-25	0.9	5.5
-20	1.4	6.2
-15	1.8	6.9
-10	2.3	7.6
-5	2.7	8.4
0	3.2	9.1
5	3.6	9.8
10	4.1	10.5
15	4.5	11.3
20	5.0	12.0
25	5.5	12.7
30	5.9	13.5
35	6.4	14.2
40	6.8	14.9
45	7.3	15.6
50	7.7	16.4
55	8.2	17.1
60	8.6	17.8
65	9.1	18.5
70	9.5	19.2
75	10.0	20.0

Temperature table
MR: -35...+35 °C

°C	U _A [V]	I _A [mA]
-35	0.0	4.0
-30	0.7	5.1
-25	1.4	6.3
-20	2.1	7.4
-15	2.9	8.6
-10	3.6	9.7
-5	4.3	10.9
0	5.0	12.0
5	5.7	13.1
10	6.4	14.3
15	7.1	15.4
20	7.9	16.6
25	8.6	17.7
30	9.3	18.9
35	10.0	20.0

Temperature table
MR: 0...+50 °C

°C	U _A [V]	I _A [mA]
0	0.0	4.0
5	1.0	5.6
10	2.0	7.2
15	3.0	8.8
20	4.0	10.4
25	5.0	12.0
30	6.0	13.6
35	7.0	15.2
40	8.0	16.8
45	9.0	18.4
50	10.0	20.0

Temperature table
MR: 0...+80 °C

°C	U _A [V]	I _A [mA]
0	0.0	4.0
5	0.6	5.0
10	1.3	6.0
15	1.9	7.0
20	2.5	8.0
25	3.1	9.0
30	3.8	10.0
35	4.4	11.0
40	5.0	12.0
45	5.6	13.0
50	6.3	14.0
55	6.9	15.0
60	7.5	16.0
65	8.1	17.0
70	8.8	18.0
75	9.4	19.0
80	10.0	20.0

Humidity table
MR: 0...100% RH

% RH	U _A [V]	I _A [mA]
0	0.0	4.0
5	0.5	4.8
10	1.0	5.6
15	1.5	6.4
20	2.0	7.2
25	2.5	8.0
30	3.0	8.8
35	3.5	9.6
40	4.0	10.4
45	4.5	11.2
50	5.0	12.0
55	5.5	12.8
60	6.0	13.6
65	6.5	14.4
70	7.0	15.2
75	7.5	16.0
80	8.0	16.8
85	8.5	17.6
90	9.0	18.4
95	9.5	19.2
100	10.0	20.0

On-wall humidity sensors and temperature sensors ($\pm 1.8\%$),
calibratable, with multi-range switching
and active output

AFTF-20-VAQ
with M12 connector



HYGRASGARD® AFTF-20-VAQ On-wall humidity sensors and temperature sensors ($\pm 1.8\%$), *ID*
(with M12 connector)

Type / WG02I	Measuring Range / Readout		Output		Display	Item No.	Price
	Humidity	Temperature	Humidity	Temperature	● = Q		
AFTF-20-VAQ						[active]	
AFTF-20-I VAQ	0...100% RH	-35...+75 °C -35...+35 °C 0...+50 °C 0...+80 °C	4...20 mA	4...20 mA	●	2003-6181-2100-001	709,52 €
AFTF-20-I VAQ LCD	0...100% RH	(4x as above)	4...20 mA	4...20 mA	● ■	2003-6182-2100-001	875,98 €
AFTF-20-U VAQ	0...100% RH	-35...+75 °C -35...+35 °C 0...+50 °C 0...+80 °C	0-10V	0-10V	●	2003-6181-1100-001	709,52 €
AFTF-20-U VAQ LCD	0...100% RH	(4x as above)	0-10V	0-10V	● ■	2003-6182-1100-001	875,98 €
Housing variant "Q":	Cable connection with M12 connector (male, 5-pin, A-code)						

ACCESSORIES

SF-M	Metal sinter filter, Ø 16 mm, L = 32 mm, exchangeable stainless steel V4A (1.4404)	7000-0050-2200-100	45,34 €
-------------	---	--------------------	----------------

For further information see last chapter!



S+S REGELTECHNIK

HYGRASGARD® AFTF-20-VA

On-wall humidity sensors and temperature sensors ($\pm 1.8\%$),
calibratable, with multi-range switching
and active output



AFTF-20-VA
with cable gland



HYGRASGARD® AFTF-20-VA		On-wall humidity sensors and temperature sensors ($\pm 1.8\%$), <i>ID</i> (with cable gland)					
Type / WG02I	Measuring Range / Readout		Output		Display	Item No.	Price
	Humidity	Temperature	Humidity	Temperature			
AFTF-20-VA							
AFTF-20-I VA	0...100% RH	-35...+75 °C -35...+35 °C 0...+50 °C 0...+80 °C	4... 20 mA	4... 20 mA		2003-6181-2200-001	668,24 €
AFTF-20-I VA LCD	0...100% RH	(4x as above)	4... 20 mA	4... 20 mA	■	2003-6182-2200-001	834,71 €
AFTF-20-U VA	0...100% RH	-35...+75 °C -35...+35 °C 0...+50 °C 0...+80 °C	0-10 V	0-10 V		2003-6181-1200-001	668,24 €
AFTF-20-U VA LCD	0...100% RH	(4x as above)	0-10 V	0-10 V	■	2003-6182-1200-001	834,71 €
Housing variant:		Cable connection with cable gland					

ACCESSORIES			
SF-M	Metal sinter filter, \varnothing 16 mm, L = 32 mm, exchangeable stainless steel V4A (1.4404)	7000-0050-2200-100	45,34 €
For further information see last chapter!			